

MiMA

Min. space Max. performance

BANYITONG SCIENCE & TECHNOLOGY DEVELOPING CO.,LTD.

Add: Crossing of Daihe Road and Cailun Road,Hefei,China

Tel: +86 551 6425 5078

Fax: +86 551 6211 3877

E-mail: sales@mimachina.com

Website: www.mimaforklift.com



Website

Articulated Forklift MJ20 Series



Indoor & Outdoor One - Stop Handling and Intensive Storage

MiMA[®]

BANYITONG SCIENCE &
TECHNOLOGY DEVELOPING CO.,LTD.
www.mimaforklift.com

Ultra-high storage capacity

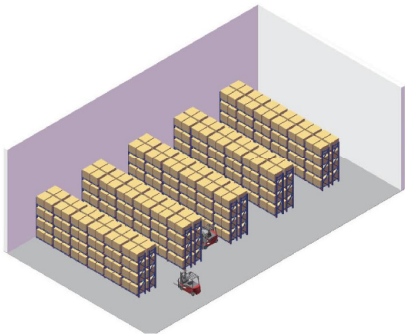

Electric counterbalanced forklift

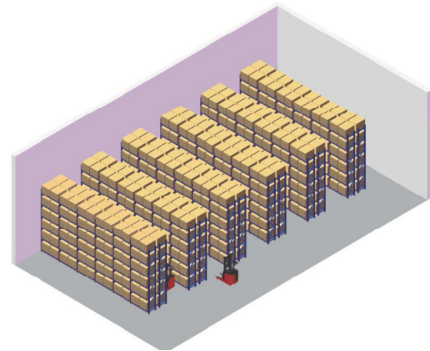

Reach Truck

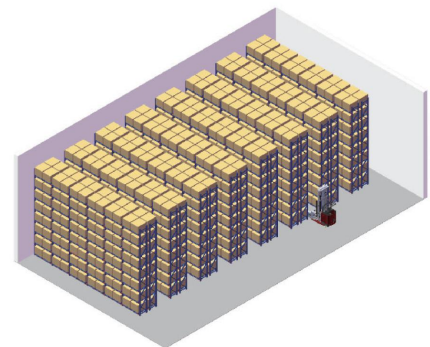

Articulated forklift

Narrow aisle

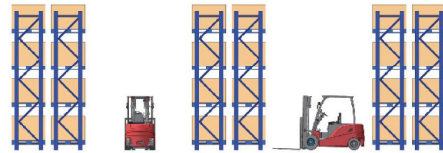

Rack height 5M

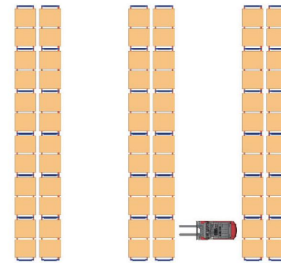

Aisle width 4M

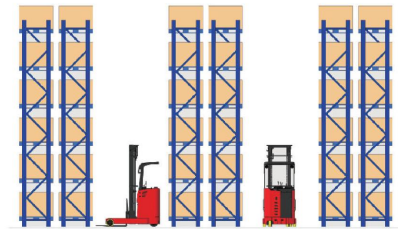

Rack height 7.5M

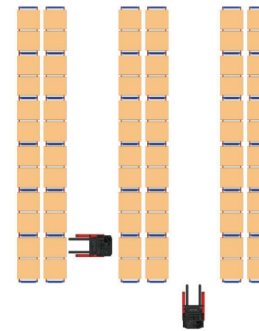

Aisle width 3M

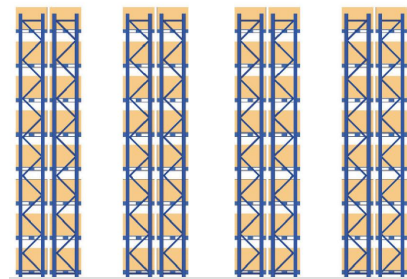

Rack height $\geq 10M$, Up to 12.5m

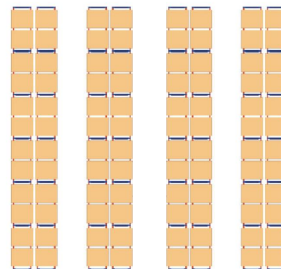

Aisle width 1.9M-2.2M

- Electric counterbalanced forklift
- Few pallet positions
- Large aisle width (Around 4M)
- Low rack height (Around 5M)
- High cost for single pallet position



- Reach Truck
- Compared with counterbalanced forklift
- Pallet positions have increased by 80%
- Rack height has increased by 40% (Around 7.5M)
- Aisle width has decreased by 25% (Around 3M)
- Based on same storage area
- Cost for single pallet position has decreased by 40%



- Articulated forklift
- Compared with counterbalanced forklift
- Pallet positions have increased by 200%
- Rack height has increased by 100% ($\geq 10M$)
- Aisle width has decreased by 45% (1.9M)
- Based on same storage area
- Cost for single pallet position has decreased by 60%



NARROW AISLE AND HIGH STORAGE CAPACITY

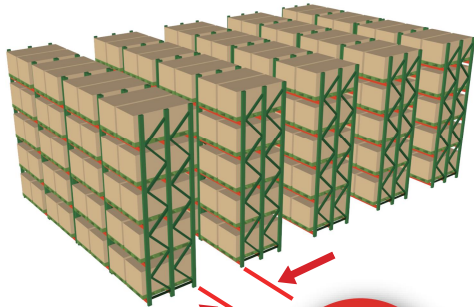

Compared with the traditional rack arrangement scheme, the racking aisle suitable for the articulated forklift can be reduced to a minimum of 1.9 meters, so that the storage capacity can be greatly increased.

Min. Aisle Width
≥ 1,900MM



MJ Series Articulated Forklift

It can be used conveniently both indoors and outdoors. The operator can complete a series of operations such as loading/unloading, handling and stacking through an articulated forklift. The forklift is equipped with solid rubber tires, with a mast swing angle of 210 degrees, an ultra-small turning radius, and flexible and comfortable operation.



210°

210° mast swing angle

UP TO 12,500 MM

Load Capacity
2000KG

Max. Lifting Height
Up to 12,500MM

The articulated forklift is designed for faster and more efficient loading and unloading goods outdoor and indoor, as well as meeting the narrow aisle intensive storage. The articulated forklift has the functions of traditional counter-balanced forklift, pallet truck and high-level storage forklift, and truly achieves one-stop indoor and outdoor material handling and storage.

The forklift is equipped with maintenance-free full AC motors, and the high-speed ratio gearbox provides sufficient power for driving and climbing. Excellent ergonomic design ensures high efficiency and comfortable driving.



Indoors and Outdoors Using



The forklift is equipped with front and rear solid rubber tires, which can adapt to various indoor and outdoor ground conditions. The high chassis design has excellent trafficability. Besides, the forklift adopts a high-power AC drive motor with a better climbing performance.



High speed driving High efficient work

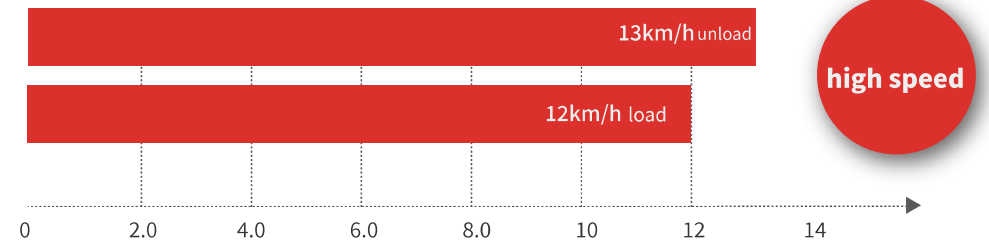

The articulated forklift is equipped with super high-power AC drive motor to provide sufficient power;
The max driving speed with full load can reach 12km/h, and the max driving speed with no load can reach 13km/h

Flexible steering Easy Operation in Narrow Aisle Width

The mast swing angle is 210 degree. When turning, the max. mast swing angle is 210 degree.



Various configuration Comfortable operation



Lift height	4600--12500mm
Rated capacity	2000kg
Load center	600mm
Drive speed, load/unload	12/13km/h
Max.gradeability, load/unload	12%/13%
Drive motor type	AC
Lift motor type	AC
Battery, voltage/capacity	48V900AH/80V500AH
Turning radius	2200mm

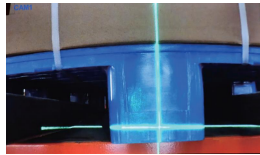

Laser-assisted alignment of forks
Laser-assisted alignment of forklift

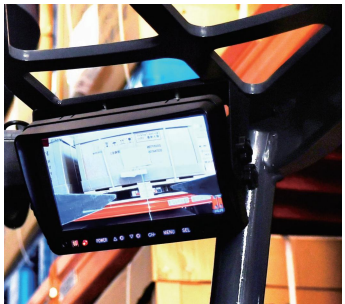

HD camera display



Options:Electric proportion integrated handle,
easier operation and more accurate

Super power

Low energy consumption

Long work life

- 48V system with AC 18.5KW drive motor
- 80V system with AC 16.3KW drive motor
- High power maintenance-free AC drive motor provides super power
- High power AC 15KW lift motor provides sufficient power for hydraulic system, which makes operation more stable
- 80V system with higher voltage and lower current, which makes the energy consumption more optimized and provide long work life

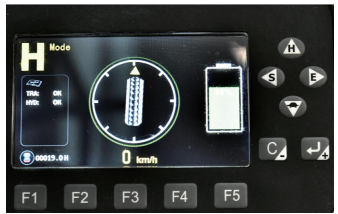

LCD display



High strength overhead guard for safer protection
Grid top design for better view

Specification

Standard					
1.1	Manufacturer	MIMA	MIMA	MIMA	MIMA
1.2	Model	MJ20 (narrow)	MJ20H(wide)	MJ20(narrow)	MJ20H(wide)
1.3	Power type	Battery	Battery	Battery	Battery
1.4	Operation type	Seated	Seated	Seated	Seated
1.5	Rated capacity	Q(kg)	2000	2000	2000
1.6	Load center	C(mm)	600	600	600
1.7	Load distance	x(mm)	285	285	285
1.8	Wheelbase	y(mm)	1720	1720	1720

Weights						
2.1	Service weight (incl.battery)	kg	7460	8140	7460	8140
2.2	Axle load with load, drive side/load side	kg	5290/4250	5600/4650	5290/4250	5600/4650
2.3	Axle load without load, drive side/load side	kg	2250/5210	2470/5670	2250/5210	2470/5670

Tyres						
3.1	Tyre type		Solid rubber tire	Solid rubber tire	Solid rubber tire	Solid rubber tire
3.2	Tyre size, load side	mm	Φ457×178	Φ457×178	Φ457×178	Φ457×178
3.3	Tyre size, Drive wheel	mm	Φ415×178	Φ415×178	Φ415×178	Φ415×178
3.4	Number of wheels, front/rear X=drive		2X/2	2X/2	2X/2	2X/2
3.5	Tread, drive side	b10(mm)	800	800	800	800
3.6	Tread, load side	b11(mm)	1090	1090	1090	1220

Dimension						
4.1	Mast tilt, forward/backward	α/β(°)	1/3	1/3	1/3	1/3
4.2	Mast swing angle	(°)	210	210	210	210
4.3	Height, mast closed	h1(mm)	See the mast parameter table	See the mast parameter table	See the mast parameter table	See the mast parameter table
4.4	Free lift height	h2(mm)	See the mast parameter table	See the mast parameter table	See the mast parameter table	See the mast parameter table
4.5	Rated weight lift height	h3(mm)	3300	3300	3300	3300
4.6	Lift height range	h3(mm)	4600~10000	4600~12500	4600~10000	4600~12500
4.7	Height, mast extended	h4(mm)	See the mast parameter table	See the mast parameter table	See the mast parameter table	See the mast parameter table
4.8	Overhead guard height	h6(mm)	2250	2250	2250	2250
4.9	Seat height	h7(mm)	1230	1230	1230	1230
4.10	Overall length	L1(mm)	3830	3830	3830	3830
4.11	Overall length without forks	L2(mm)	2730	2730	2730	2730
4.12	Overall width	b1/b2(mm)	980/1260	980/1400	980/1260	980/1400
4.13	Fork size	l/e/s(mm)	1100/100/50	1100/100/50	1100/100/50	1100/100/50
4.14	Installation level	II	II	II	II	II
4.15	Fork carriage width	b3(mm)	990	990	990	990
4.16	Outside distance between forks	b5(mm)	250~890	250~890	250~890	250~890
4.17	Side shift distance	mm	±100	±100	±100	±100
4.18	Min. ground clearance of mast	m1(mm)	70	70	50	50
4.19	Min. Ground clearance of chassis	m2(mm)	100	100	100	100
4.20★	Min. stacking aisle width (800X1200mm pallet, C=600mm)	mm	1900	2100	1900	2100
	Efficiency aisle Distance between goods to goods ≥	mm	2000	2200	2000	2200
	Distance between rack to rack ≥	mm	2200	2400	2200	2400
	More other stacking aisle width	mm	See aisle parameter table	See aisle parameter table	See aisle parameter table	See aisle parameter table
4.21	Min. main aisle (800X1200mm pallet)	mm	2650	2650	2650	2650
4.22	Turning radius	Wa(mm)	2200	2200	2200	2200

Performance						
5.1	Driving speed, load/unload	km/h	12/13	12/13	12/13	12/13
5.2	Lifting speed, load/unload	mm/s	400/420	400/420	400/420	400/420
5.3	Lowering speed, load/unload	mm/s	280/200	280/200	280/200	280/200
5.4	Traction (S2-5min)	N				
5.5★	Max. Gradeability from slope load/unload (S2-5min)	%(tanθ)	15/15	15/15	15/15	15/15
5.6	Braking type		Hydraulic	Hydraulic	Hydraulic	Hydraulic

Driving						
6.1	Drive motor (S2-60min)	kw	AC18.5	AC18.5	AC16.3	AC16.3
6.2	Lifting motor (S3-15%)	kw	AC15	AC15	AC15	AC15
6.3	Battery, voltage/capacity	V/Ah	48/900	48/900	80/500	80/500
6.4	Battery weight	kg	1400	1400	1380	1380
6.5	Steering type		Hydraulic	Hydraulic	Hydraulic	Hydraulic

Others						
7.1	Lithium battery, voltage/capacity (standard)	V/Ah	48/600	48/600	80/460	80/460
7.2	(Optional)	V/Ah	48/700	48/700	80/400	80/400

Marks: Above data is for standard model. Varies depending on different configuration. 4.20★ The minimum aisle is the net width between goods and goods, and the distance between rack and rack should be increased accordingly, it is recommended to add 200 mm or more. 5.5★ It is the maximum gradeability from the slope, and the maximum gradeability (load/unload) is 15/15.

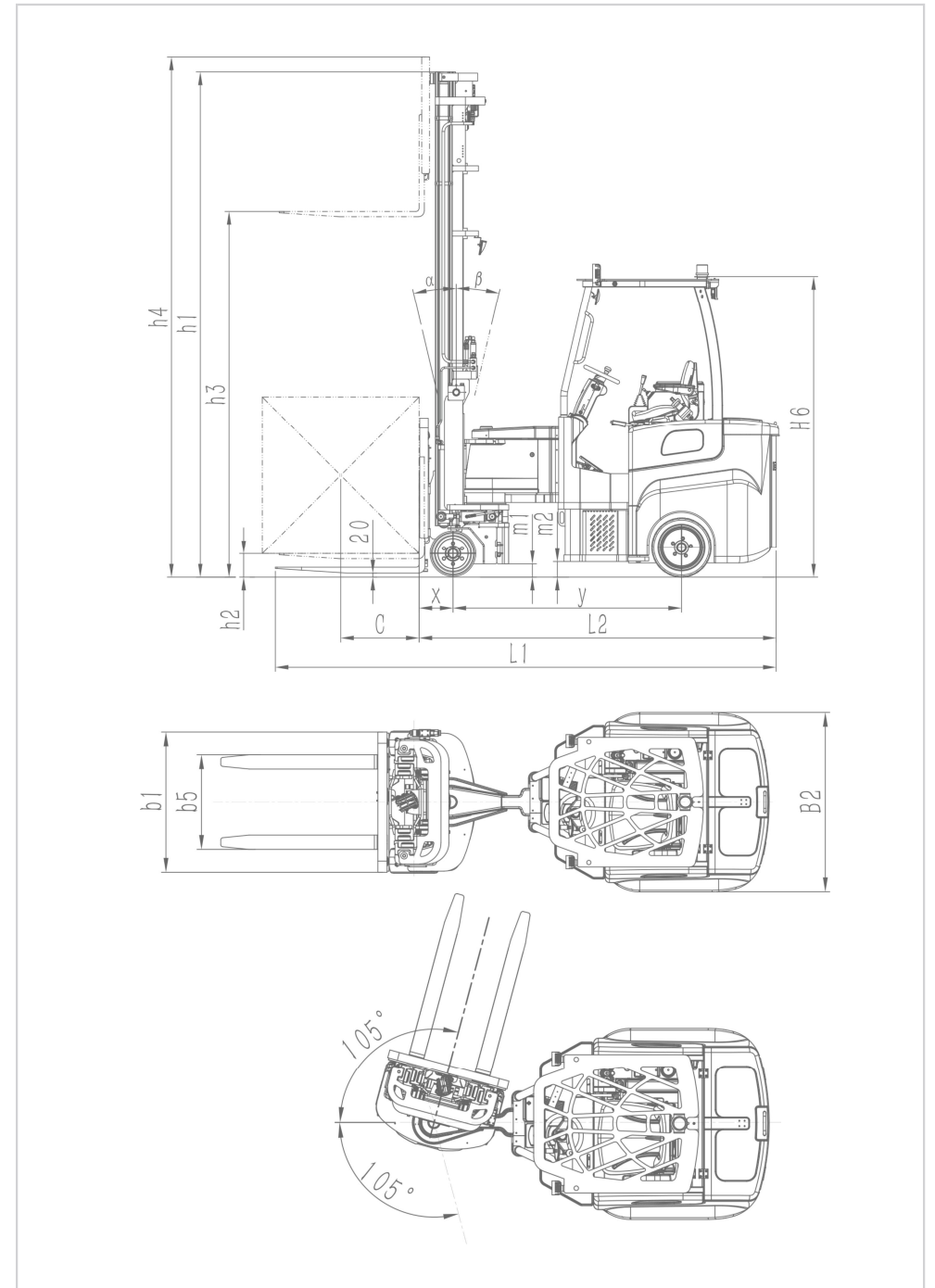

Load capacity parameter									MJ20 Narrow model
Lift height (mm)									Capacity kg
	10000	500	470	450	430	410	390	370	
	9500	650	620	580	560	530	510	490	
	9000	780	740	700	670	640	610	580	
	8500	880	830	790	750	720	690	660	
	8000	950	900	850	810	780	740	710	
	7500	1050	990	940	900	860	820	790	
	7150	1080	1020	970	920	880	840	810	
	7000	1100	1040	990	940	900	860	820	
	6750	1150	1090	1030	980	940	900	860	
	6300	1200	1140	1080	1030	980	940	900	
	5700	1300	1230	1170	1110	1060	1010	970	
	5400	1350	1280	1210	1160	1100	1050	1010	
	4800	1400	1330	1260	1200	1140	1090	1050	
	4600	1450	1370	1300	1240	1180	1130	1080	
3300	2000	1890	1800	1710	1630	1560	1500		
		600	650	700	750	800	850	900	
Horizontal load center mm									

Load capacity parameter									MJ20W Semi-wide model
Lift height (mm)									Capacity kg
	12500	/	/	/	/	/	/	/	
	12000	/	/	/	/	/	/	/	
	11500	/	/	/	/	/	/	/	
	11000	/	/	/	/	/	/	/	
	10800	/	/	/	/	/	/	/	
	10500	/	/	/	/	/	/	/	
	10000	800	760	720	680	660	620	600	
	9500	900	850	810	770	730	700	670	
	9000	950	900	850	810	780	740	710	
	8500	1050	990	940	900	860	820	790	
	8000	1150	1090	1030	980	940	900	860	
	7500	1250	1180	1120	1070	1020	980	930	
	7150	1300	1230	1170	1110	1060	1010	970	
	7000	1350	1280	1210	1160	1100	1050	1010	
6750	1380	1310	1240	1180	1130	1080	1030		
6300	1450	1370	1300	1240	1180	1130	1080		
5700	1530	1450	1380	1310	1250	1190	1140		
5400	1600	1510	1440	1370	1310	1250	1200		
4800	1680	1590	1510	1440	1370	1310	1260		
4600	1750	1660	1570	1500	1430	1370	1310		
3300	2000	1890	1800	1710	1630	1560	1500		
		600	650	700	750	800	850	900	
Horizontal load center mm									

Load capacity parameter									MJ20H Wide model		
Lift height (mm)									Capacity kg		
	12500	900	850	810	770	730	700	670			
	12000	950	900	850	810	780	740	710			
	11500	1000	950	900	860	820	780	750			
	11000	1050	990	940	900	860	820	790			
	10800	1070	1010	960	920	870	840	800			
	10500	1100	1040	990	940	900	860	820			
	10000	1200	1140	1080	1030	980	940	900			
	9500	1230	1160	1110	1050	1000	960	920			
	9000	1250	1180	1120	1070	1020	980	930			
	8500	1300	1230	1170	1110	1060	1010	970			
	8000	1350	1280	1210	1160	1100	1050	1010			
	7500	1400	1330	1260	1200	1140	1090	1050			
	7150	1430	1350	1290	1220	1170	1120	1070			
	7000	1500	1420	1350	1280	1220	1170	1120			
6750	1530	1450	1380	1310	1250	1190	1140				
6300	1550	1470	1390	1330	1270	1210	1160				
5700	1600	1510	1440	1370	1310	1250	1200				
5400	1630	1540	1470	1390	1330	1270	1220				
4800	1730	1640	1560	1480	1410	1350	1290				
4600	1800	1700	1620	1540	1470	1410	1350				
3300	2000	1890	1800	1710	1630	1560	1500				
		600	650	700	750	800	850	900			
Horizontal load center mm											

Mast parameter											
Triplex full free mast											
Model	MJ20	46	48	54	57	63	67	70	71	75	80
Lift height	h3(mm)	4620	4820	5420	5720	6320	6770	7020	7170	7520	8020
Mast extended height	h4(mm)	5800	6000	6600	6900	7500	8000	8200	8400	8700	9200
Mast closed height	h1(mm)	2818	2885	3085	3185	3385	3485	3568	3618	3734	3900
Free lift height	h2(mm)	1134	1200	1400	1500	1700	1950	2034	2084	2202	2368
Triplex full free mast											
Model	MJ20	85	90	95	100	105	108	110	115	120	125
Lift height	h3(mm)	8520	9020	9520	10020	10520	10820	11020	11520	12020	12520
Mast extended height	h4(mm)	9700	10200	10700	11200	11700	12000	12200	12700	13200	13700
Mast closed height	h1(mm)	4067	4234	4400	4567	4734	4834	4900	5067	5234	5400
Free lift height	h2(mm)	2534	2700	2868	3034	3200	3300	3368	3534	3700	3868

Stacking aisle width parameter MJ20 Narrow model

		Pallet size along forks direction (L)									Swing angle
		mm	1000	1100	1200	1300	1400	1500	1600	1700	
Pallet size across forks direction (w)	800	/	/	1900	2050	2150	2250	/	/	/	±105
	900	/	/	1950	2080	2180	2280	/	/	/	
	1000	1800	1900	2000	2100	2200	2300	2400	2500	2600	
	1100	1830	1930	2030	2130	2230	2330	2430	2530	2630	
	1200	1850	1950	2050	2150	2250	2350	2450	2550	2650	±100
	1300	1900	2000	2150	2200	2300	2400	2500	2600	2700	
	1400	2000	2100	2200	2300	2400	2500	2600	2700	2800	±95
	1500	2350	2450	2550	2650	2750	2850	2950	3050	3150	±90
1600	2400	2500	2600	2700	2800	2900	3000	3100	3200		

Stacking aisle width parameter MJ20W Semi-wide model MJ20H Wide model

		Pallet size along forks direction (L)									Swing angle
		mm	1000	1100	1200	1300	1400	1500	1600	1700	
Pallet size across forks direction (w)	800	/	/	2100	2250	2350	2450	/	/	/	±105
	900	/	/	2150	2280	2380	2480	/	/	/	
	1000	2000	2100	2200	2300	2400	2500	2600	2700	2800	
	1100	2030	2130	2230	2330	2430	2530	2630	2730	2830	
	1200	2050	2150	2250	2350	2450	2550	2650	2750	2850	±100
	1300	2100	2200	2300	2400	2500	2600	2700	2800	2900	
	1400	2200	2300	2400	2500	2600	2700	2800	2900	3000	±95
	1500	2350	2450	2550	2650	2750	2850	2950	3050	3150	±90
1600	2400	2500	2600	2700	2800	2900	3000	3100	3200		

Note 1 : The above indicates minimum aisle width, which is the net aisle width between goods to goods; when the goods extend out of racks, the aisle width need to be increased accordingly, recommended to be added 200 or more, efficiency net aisle width needs to be added 100 or more.
 Note 2 : When W is bigger than 1200mm, lift height is less than 2500mm, the swing angle will be less than 21.0 degree. The larger W, the smaller swing angle.

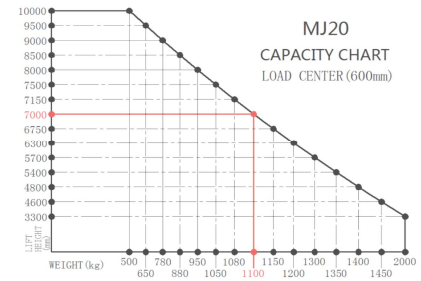

Capacity Chart-MJ20

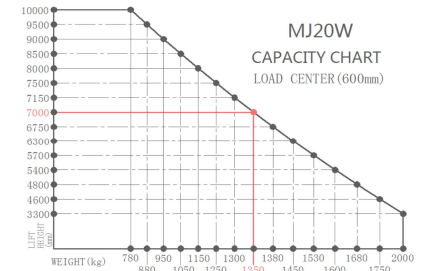

Capacity Chart-MJ20W

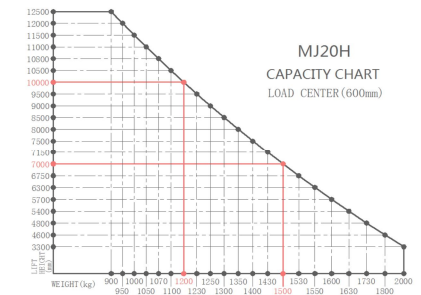

Capacity Chart-MJ20H