

## CPD13SH/15SH

A2G2/A2LIG2



# HELI



# 1.3-1.5 t

G2 series three wheel counterbalance forklift truck with rear drive wheels



**ANHUI HELI CO., LTD.**

Add / No.668, FangXing Road, Hefei, China

Fax / +86-551-63639966

Tel / +86-551-63639068(America); 63639258(Europe);

63639358(Asia); 63662105(Africa & Middle East)

\* Our products are subject to improvements and changes without notice.



LinkedIn



YouTube



Facebook



**DELICATE APPEARANCE  
AND STRONG POWER**

# Upgraded platform and improved performance

High performance and guaranteed efficiency



Driving speed 12-12.5km/h



1.3t: maximum gradeability with load 13%  
1.5t: maximum gradeability with load 11%



Maximum lifting speed with load 0.28m/s



Maximum lifting speed without load 0.48m/s



Good bearing capacity at high position

## New platform

- Lead acid lithium batteries share the same platform, and the parts are highly universal.
- The dashboard cover is upgraded to be more beautiful and durable.
- Delicate and compact appearance, flexible operation.
- The truck has excellent trafficability, and the minimum turning radius is only 1.46M.



Lead-acid Platform



Lithium Platform



Minimum turning radius as low as **1.46m**

Fast charging, super long endurance

- 48V platform offers higher charging efficiency.
- Realizes faster charging: maximum 456Ah lithium battery has ultra-long endurance.
- The characteristics of high-density energy and quick charging of lithium battery make all day uninterrupted operation of a forklift truck.

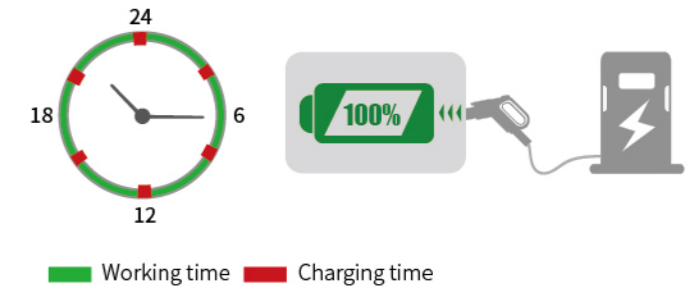

Good accessories and optimized design details

- Two in one integrated dual core electronic control, small size, in line with the new CE standard.
- Maintenance free IP54 AC motor.
- Integrated handheld function color screen instrument and graphical interface design offer simple and intuitive operation.
- Load sensitive hydraulic system reduces system heating which makes operation more accurate and energy saving.
- Ultra low torque steering gear reduces steering operating torque and makes operation easier.



Two in one integrated dual core electronic control

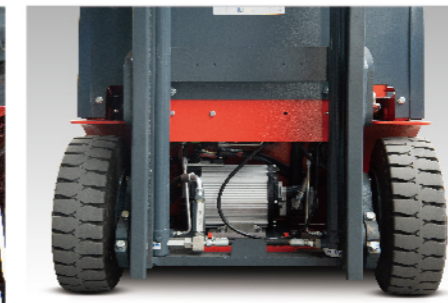

IP54 AC Motor



Color screen instrument

## FICS domestic Basic Edition

### HELI smart fleet management system (domestic basic edition)

Vehicle positioning	Statistical form
Remote diagnosis	Vehicle management
Remote monitoring	Identification recognition (optional)
Maintenance reminder	Weight management (optional)
Battery management	Collision management (optional)



# Humanized design, comfortable and intimate

The mast has a wide view to improve the comfort and safety of operation.

Front and rear adjustable of steering wheel



Right control valve rod



Extra large foot space

# Easy use and Maintenance

- Electrical components such as electronic control are centrally and horizontally arranged above the counterweight, with better heat dissipation capacity.
- Open the box cover for maintenance, which is more convenient and hassle free.
- Integrated electric box is easy to maintain.
- The front bottom plate is of split type, and the accelerator pedal is installed on the frame. The bottom plate is easy for disassemble and overhaul.



Electrical components



The front bottom plate is of split type

# Intelligent security

- Intelligent speed limit in different application: multi-scenario identification and intelligent speed limit balance efficiency and safety.
- Intelligent limit buffering : intelligent induction of mast lifting and lowering avoids extreme impact and is safe and comfortable.
- Intelligent operation protection: a full set of OPS system can avoid misoperation and ensure safety.
- Intelligent control strategy: dual core controller is in line with the latest EU safety requirements.
- Lithium battery which heats itself automatically at low temperatures has excellent low temperature adaptability.

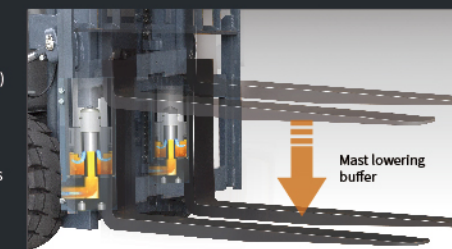
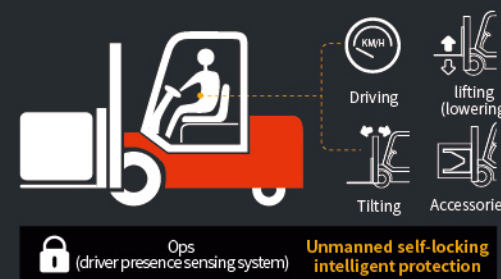

Mast lowering buffer

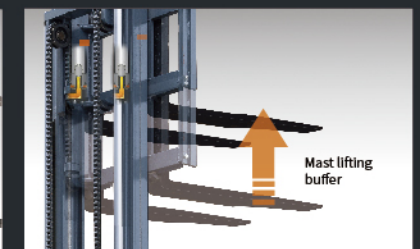

Mast lifting buffer

## Manufacturer and Technical Data

### Characteristics

		<b>HELI</b>			
		CPD13SH		CPD15SH	
1.01	Manufacturer	<b>HELI</b>			
1.02	Model	CPD13SH		CPD15SH	
1.03	Configuration number	A2G2		A2LIG2	
1.04	Rated capacity	Q	kg	1300	1500
1.05	Load center distance	c	mm	500	
1.06	Power mode	Storage battery		Lithium Battery	
1.07	Driving mode	Seated			
1.08	Front overhang	x	mm	330 (352*)	
1.09	Wheelbase	y	mm	1190	
<b>Weight</b>					
2.01	Total weight (with/without battery)		kg	2795/2270	2930/2340
2.02	Axle load (laden,front/rear)		kg	3430/680	3750/680
2.03	Axle load (unladen,front/rear)		kg	1205/1605	1170/1760
<b>Tyre type</b>					
3.01	Tyre size,front	Superelastic solid tyre			
3.02	Tyre size,rear	18X7-8			
3.03	Wheels,number front/rear (x=driven wheels)	18X7-8			
3.04	Tread, front	2/1x			
3.05	Tread, rear	b <sub>10</sub>	mm	838 (908*)	838 (908*)
<b>Dimensions</b>					
4.01	Mast tilt angle (forward/backward)	α/β	°	3/6	3/6
4.02	Height (mast lowered)	h <sub>1</sub>	mm	1955	1955
4.03	Free lifting height	h <sub>2</sub>	mm	110	110
4.04	Lifting height (standard)	h <sub>3</sub>	mm	3000	3000
4.05	Max. height,extended (with backrest)	h <sub>4</sub>	mm	4008	4008
4.06	Height of overhead guard	h <sub>6</sub>	mm	2090	2090
4.07	Seat height relating to SIP (to ground)	h <sub>7</sub>	mm	1030	1030
4.08	Towing coupling height	h <sub>10</sub>	mm	640	640
4.09	Overall length (with fork)	l <sub>1</sub>	mm	2720 (2742*)	2720 (2742*)
4.10	Overall length (without fork)	l <sub>2</sub>	mm	1800 (1822*)	1800 (1822*)
4.11	Overall width	b <sub>1</sub>	mm	990 (1060*)	990 (1060*)
4.12	Fork size:thickness x width x length	35X100X920			
4.13	Fork carriage,according to ISO2328	s/e/l	mm	2A	2A
4.14	Distance across fork-arms, Max./Min.	b <sub>5</sub>	mm	960/200	960/200
4.15	Distance across fork-arms, Max./Min.	m <sub>1</sub>	mm	80	80
4.16	Ground clearance (center of wheelbase)	m <sub>2</sub>	mm	95	95
4.17	Right angle stacking aisle width for pallet 1000x1200mm crossways	A <sub>st</sub>	mm	3130 (3150*)	3130 (3150*)
4.18	Right angle stacking aisle width for pallet 800x1200mm lengthways	A <sub>st</sub>	mm	3252 (3273*)	3252 (3273*)
4.19	Min. outside turning radius	W <sub>a</sub>	mm	1470	1470
<b>Performance Data</b>					
5.01	Travel speed (laden/unladen)		km/h	12/12.5	12/12.5
5.02	Lift speed (laden/unladen)		mm/s	290/480	280/480
5.03	Lowering speed (laden/unladen)		mm/s	405/330	405/330
5.04	Max.drawbar pull (laden/unladen)		N	7400	7400
5.05	Max.gradeability (laden/unladen)		%	13/20	11/18
5.06	Acceleration time(10 m)(laden/unladen)		s	6.1/5.5	6.1/5.5
<b>Battery</b>					
6.01	Battery voltage/Capacity		V/Ah	48/315	48/228
6.02	Battery weight (Min./Max.)		kg	525/635	590/635
6.03	Battery,according to DIN			43535A	-
<b>Motor and controller</b>					
7.01	Driving motor powering (S2-60min)		kW	6	6
7.02	Lifting motor powering (S3-15%)			8	8
7.03	Driving motor controlling mode			MOSFET/AC	
7.04	Lifting motor controlling mode			MOSFET/AC	
<b>Addition data</b>					
8.01	Service brake/Parking brake			Hydraulic/mechanical	
8.02	Operating pressure for attachments		Mpa	14.5	17.5

Note: the paraters with \* standards for that of three-stage full free lift mast when is equipped.

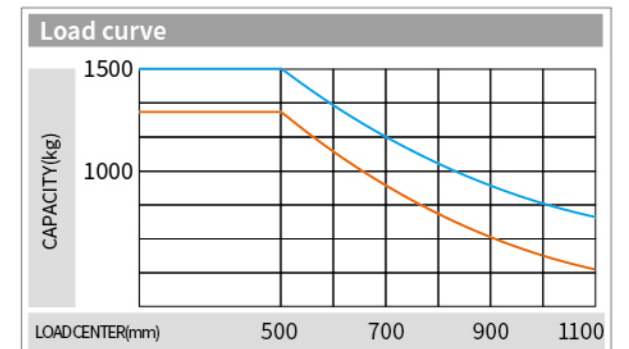
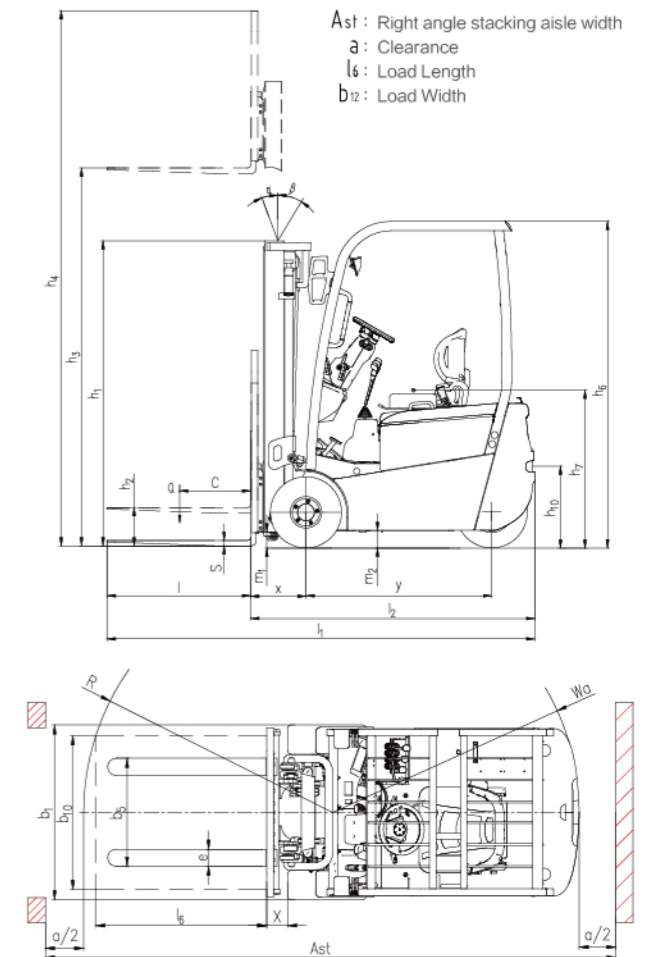

CPD13SH CPD15SH

**Note:** The vertical axis stands for load capacity and the horizontal axis stands for load center which is calculated from the front surface of the forks to the gravity of the standard load. The standard load means a cubic with 1000mm edge length. When mast is tilted forward, using non-standard forks or loading large goods, the load capacity will be reduced. The load capacity of standard mast at different load center can be known from this load chart.

## WIDE VIEW MAST

Mast model	Max lifting height mm	Load capacity (load center 500mm)		Mast overall height (fork to the ground)	Service weight		Mast tilting angle (°) α/β
		CPD13SH	CPD15SH		CPD13/15SH	CPD13SH	
M200	2000	1300	1500	1525	2730	2865	3/6
M250	2500	1300	1500	1775	2760	2895	3/6
M300	3000	1300	1500	2025	2790	2925	3/6
M330	3300	1300	1500	2175	2815	2950	3/6
M350	3500	1250	1500	2275	2825	2960	3/6
M370	3700	1250	1500	2375	2835	2970	3/6
M400	4000	1250	1450	2575	2875	3010	3/6
M425	4250	1250	1350	2700	2885	3020	3/6
M450	4500	1250	1250	2825	2905	3040	3/6
M500	5000	1150	1150	3075	2930	3065	3/3

## WIDE VIEW FULL FREE 2-STAGE MAST

Mast model	Max lifting height mm	Load capacity (load center 500mm)		Mast overall height (fork to the ground)	Free lifting height (with backrest)	Service weight		Mast tilting angle (°) α/β
		CPD13SH	CPD15SH			CPD13/15SH	CPD13/15SH	
ZM200	2000	1300	1500	1525	510	2800	2935	3/6
ZM250	2500	1300	1500	1775	760	2830	2965	3/6
ZM300	3000	1300	1500	2025	1010	2860	2995	3/6
ZM330	3300	1300	1500	2175	1160	2880	3015	3/6
ZM350	3500	1250	1500	2275	1260	2890	3025	3/6
ZM370	3700	1250	1500	2375	1360	2900	3035	3/6
ZM400	4000	1250	1450	2575	1560	2940	3075	3/6

## WIDE VIEW FULL FREE 3-STAGE MAST

Mast model	Max lifting height mm	Load capacity (load center 500mm)		Mast overall height (fork to the ground)	Free lifting height (with backrest)	Service weight		Mast tilting angle (°) α/β
		CPD13SH	CPD15SH			CPD13/15SH	CPD13/15SH	
ZSM360	3600	1250	1500	1790	781	2900	3045	3/6
ZSM400	4000	1250	1500	1925	916	2940	3075	3/6
ZSM435	4350	1250	1500	2040	1031	2960	3095	3/6
ZSM450	4500	1250	1450	2090	1081	2970	3105	3/6
ZSM470	4700	1200	1450	2160	1151	2995	3120	3/6
ZSM480	4800	1200	1450	2190	1181	2990	3125	3/6
ZSM500	5000	1150	1400	2290	1281	3000	3145	3/3
ZSM540	5400	1100	1350	2425	1416	3030	3175	3/3
ZSM600	6000	900	1000	2640	1631	3090	3235	3/3

## Configurations

Safety	Rear handle with horn for truck reversing	●	
	OPS(travelling+lifting+tilting+attachment)(lowering is not included)	●	
	Full set of OPS	○	
	Safety switch for seat belt	○	
	Hydraulic valve overload protection device	●	
	Dry powder extinguisher (0.5kg)	○	
	Dry powder extinguisher (2kg)	○	
	Backward buzzer	●	
	Reversing speaker (Chinese)	○	
	Electronic upper buffering	○	
	Wide- angle central rear view mirror	●	
	Rearview mirror on two sides+ Center wide angle rearview mirror	○	
Comfort	Semi-enclosure seat	●	
	Full suspension seat	○	
	Mechanical control valve	●	
Cab/Windshields	Fan	○	
	Front windshield (with wiper/blow can)	○	
	Rear windshield (with wiper/washer)	○	
Lights	Top windshield (without fan)	○	
	without rear working light or rear blue light	●	
	LED rear working lamp (one)	○	
	Rear LED red/blue spot lamp	○	
	Left, right and rear blue bar	○	
	Fixed type LED flicker warning lamp	●	
	Fixed type LED rotating warning lamp	○	
	Fixed type LED rotating buzzer warning lamp	○	
	Others	Peng Cheng battery	●
		He Ding battery	○
Solid tyre		●	
Traceless solid tyre		○	
Metric screw thread		●	
American screw thread		○	
HELI package		●	
Neutral package		○	
Chinese plates		●	
English plates		○	
Customized plates		○	
Universal keys (four keys )		○	
FICS standard type (domestic)	●		

Note: "●" standard; "○" optional.

## Battery,Charger

Battery voltage/Capacity	48V/315	48V/345	48V/360	48V/375
CPD13SH	●	○	○	○
CPD15SH	-	-	●	○
Charger	D48V50A-L160GB38			

Note: ● standard ;○ optional;-

## Lithium battery, Charger

Brand	HEDING			PENGCHENG			
Battery voltage/Capacity	202	280	404	228	302	346	456
CPD13SH	○	○	○	●	○	○	○
CPD15SH	○	○	○	●	○	○	○
Lithium battery which heats itself automatically at low temperatures	●						
Charger	D48V200ALi-123, D48V200ALi-423						

Note: ● standard ;○ optional;-