

## General Description of the Company

Anhui Forklift Group Corporation Ltd. (hereinafter referred as Heli) is a leading enterprise of industrial trucks in China.

Since 2016, Heli has been ranked among the top seven in the world, representing Chinese brands to forge ahead towards higher stage. (According to the "Top 20 Industrial lift truck suppliers" released by MMH.)

As the leading enterprise in China industrial truck industry, Heli has the ability and strength to participate in the global competition in a higher level, larger scale and wider field. Heli has established overseas centers in France, Thailand and the United States, which enhance the service ability in overseas market. Besides, relying on our global partners, we have established an overseas marketing and service network in more than 80 countries and regions, and Heli products are sold to more than 150 countries and regions in the world. In the next five years, Heli will vigorously promote the international operation and create a global famous brand.



# CPD15/16/ 18/20 SQ

GE1LI/GE6LI/GE2LI



**LIION 1.5-2 t**

G3 series Three-wheel Lithium Battery  
Forklift Truck (Double Drive)



**ANHUI HELI CO., LTD.**

Add / No.668, FangXing Road, Hefei, China

Fax / +86-551-63639966

Tel / +86-551-63639068(America); 63639258(Europe); 63639358(Asia);  
63662105(Africa & Middle East); 63639530(Overseas Marketing)



LinkedIn



YouTube



Facebook

\* Our products are subject to improvements and changes without notice.



**HELI**

**COMPACT BODY**  
**STRONG ENERGY**



STRONG ENERGY



## High performance ensures high efficiency

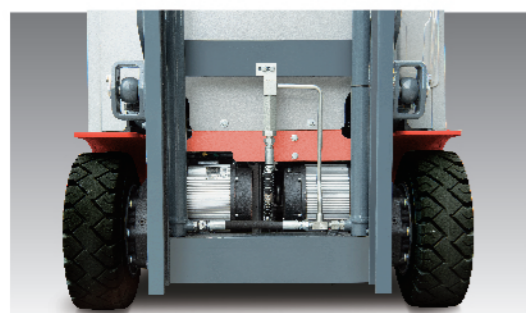

Front wheel dual drive motors provide more power.

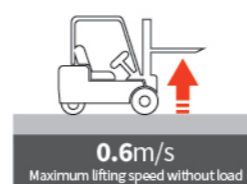
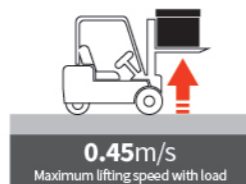
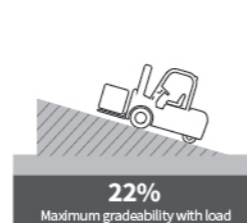
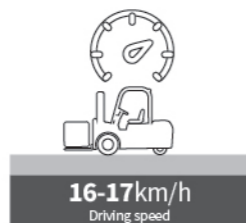

## Fast charging for long battery life



Be equipped with full hydraulic priority steering system, supply oil on demand, reduce vehicle energy consumption

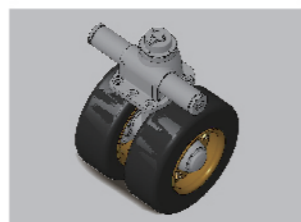

High precision angle potentiometer makes steering more sensitive and accurate.



LED light of the whole truck has high brightness, long life and is more energy saving.



Low rolling resistance electric truck special solid tire reduces driving resistance consumption.

## Small dimension, More flexible

Narrow truck width is more suitable for narrow aisle application;

Large angle steering axle makes the turning radius smaller satisfying the loading and unloading operation in narrow aisle.



## High efficient fast charging, ultra long endurance

- Realizes faster charging; standard 202ah lithium battery has ultra long endurance;
- The high density energy and fast charging characteristics of lithium battery make it possible to carry out full time operation without interruption.

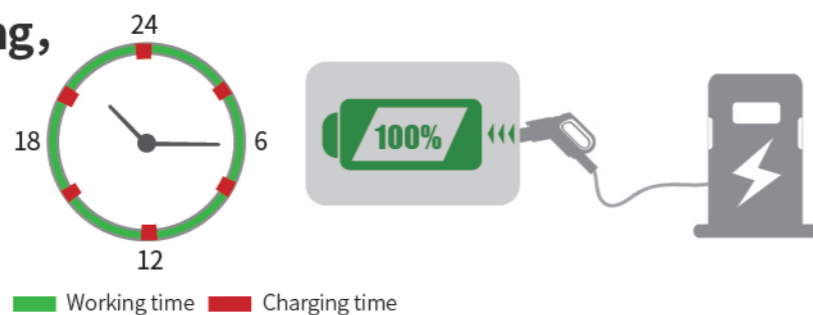

## Comfort and convenience

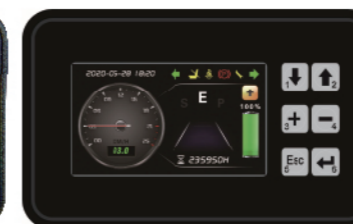

- P — Powerful
  - E — Economical
  - S — Energy-saving
- Multi-gear performance mode can adapt to a variety of working conditions at will.

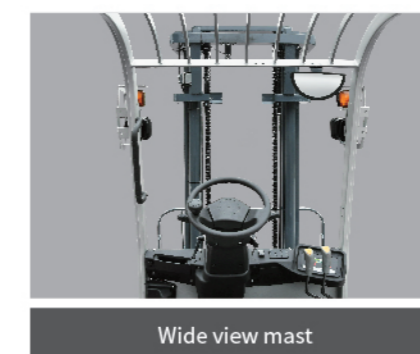
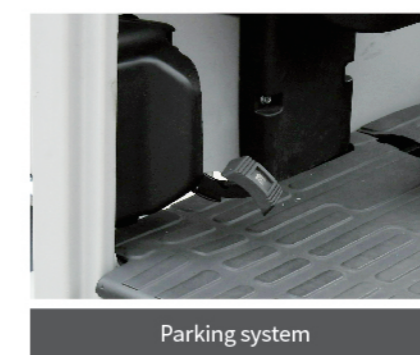



## Intelligent security protection

**Intelligent stabilization system:** it can automatically adjust the tilt angle (Solenoid valve configuration) and speed of the mast according to the lifting height and load state. Improve the high bearing capacity and vehicle stacking safety;

**Intelligent speed limit in different application:** multi-scenario identification and intelligent speed limit balance efficiency and safety;

**Intelligent limit buffering:** intelligent induction of mast lifting and lowering avoids extreme impact and is safe and comfortable;

**Intelligent operation protection:** a full set of OPS system can avoid misoperation and ensure safety;

**Intelligent control strategy:** dual core controller is in line with the latest EU safety requirements.

**Intelligent steering deceleration:** the automatic deceleration function of the turning can reduce the risk of turning over;

**Lithium battery which heats itself automatically at low temperatures has excellent low temperature adaptability.**

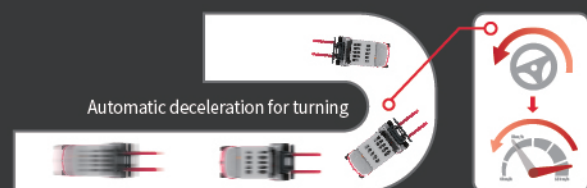
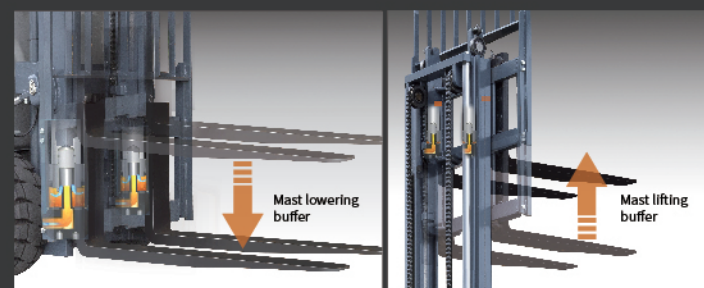
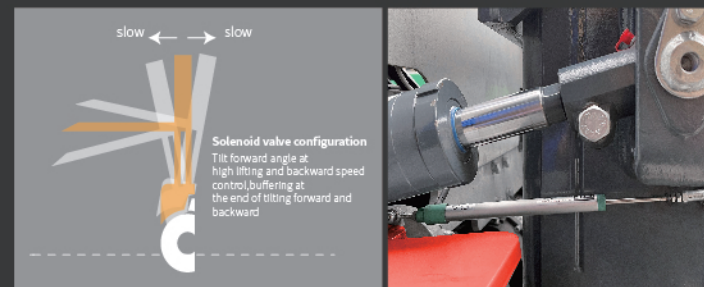

## Reliable quality, Easy maintenance

This forklift can work in cold storage at minus 20 degrees Celsius. And the reinforced cast steering axle and the mast of optimized design ensure safety.

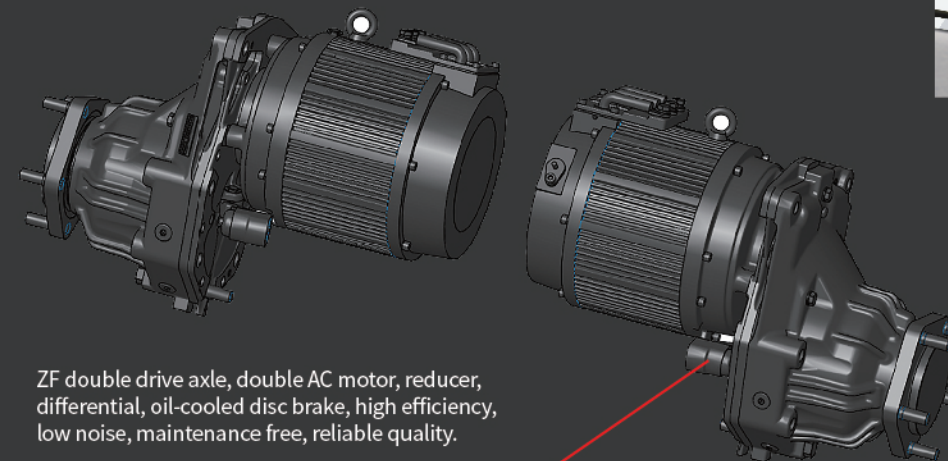

ZF double drive axle, double AC motor, reducer, differential, oil-cooled disc brake, high efficiency, low noise, maintenance free, reliable quality.

## Operating cost comparison:

Lithium battery forklift **vs.** Lead-acid battery forklift **vs.** IC forklift

The advantages of Heli lithium battery forklift trucks are more prominent in the life cycle cost. Compared with internal combustion forklift truck, lithium battery forklift truck has the advantages of no noise, no pollution, small vibration and simple operation. Compared with the lead-acid battery forklift truck, lithium battery forklift has the characteristics of fast charging and charging at any time, which is more suitable for multi shift operation. Besides, Heli lithium battery forklift is maintenance free, high power conversion efficiency, and economical overall operation cost.

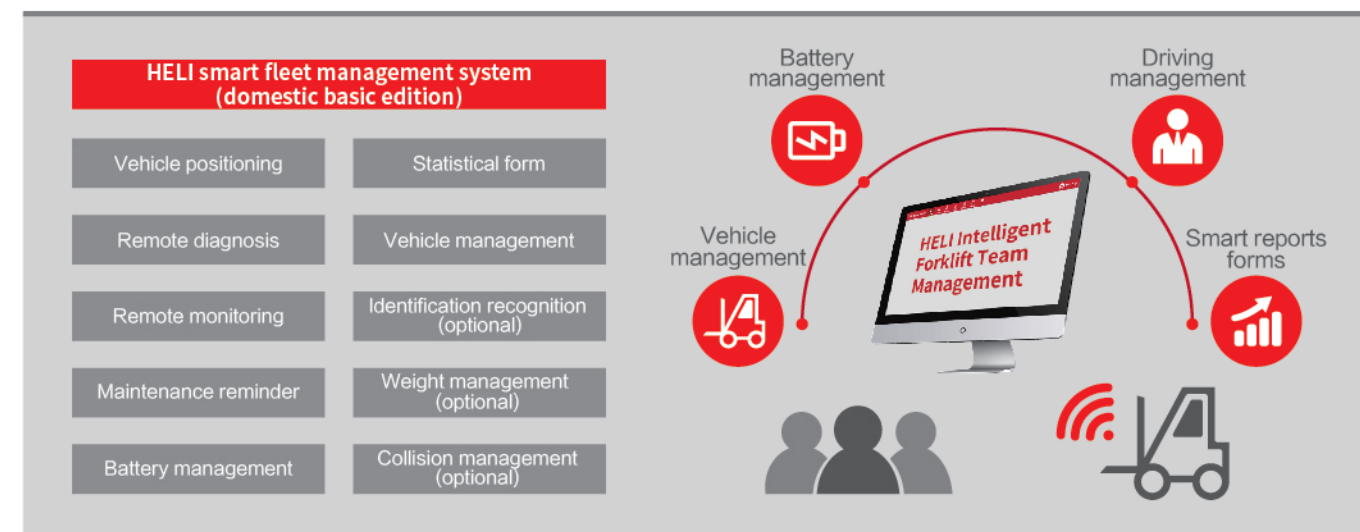
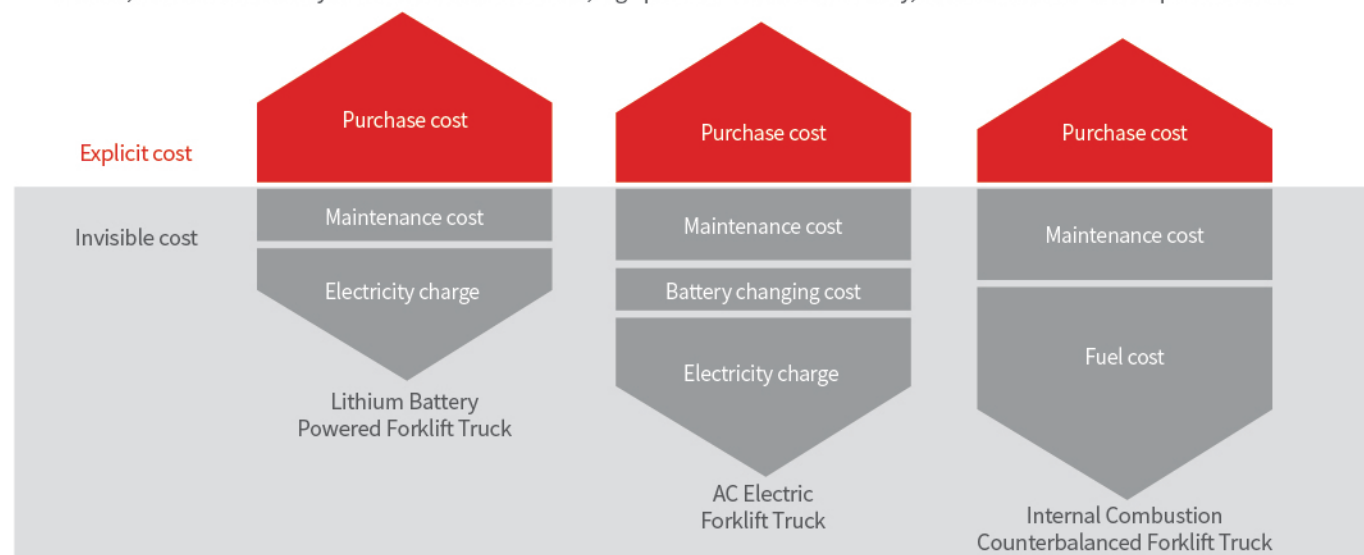



Manufacturer and Technical Data							
Characteristics							
1.01	Manufacturer			<b>HELI</b>			
1.02	Model		CPD15SQ	CPD16SQ	CPD18SQ	CPD20SQ	
1.03	Configuration number		GE1LI/GE6LI/GE2LI	GE1LI/GE6LI/GE2LI	GE1LI/GE6LI/GE2LI	GE1LI/GE6LI/GE2LI	
1.04	Rated capacity	Q	kg	1500	1600	1800	2000
1.05	Load center distance	c	mm	500			
1.06	Power mode			Lithium Battery			
1.07	Driving mode			Seated			
1.08	Load distance, center of drive axle to fork	x	mm	367	367	367	372
1.09	Wheelbase	y	mm	1292	1292	1400	1400
<b>Weight</b>							
2.01	Total weight (with/without battery)		kg	2900/2620	2935/2655	3225/2945	3330/3050
2.02	Axle load (laden,front/rear)		kg	3915/485	4035/500	4462/563	4738/545
2.03	Axle load (unladen,front/rear)		kg	1319/1581	1335/1600	1496/1728	1545/1788
<b>Tyres</b>							
3.01	Tyre type			SE			
3.02	Tyre size,front			18X7-8	18X7-8	200/50-10	200/50-10
3.03	Tyre size,rear			140/55-9	140/55-9	140/55-9	140/55-9
3.04	Wheels,number front/rear (x=driven wheels)			2x/2	2x/2	2x/2	2x/2
3.05	Tread, front	b <sub>10</sub>	mm	920	920	928	928
3.06	Tread, rear	b <sub>11</sub>	mm	198	198	248	248
<b>Dimensions</b>							
4.01	Mast tilt angle (forward/backward)	α/β	°	5/7	5/7	5/7	5/7
4.02	Height (mast lowered)	h <sub>1</sub>	mm	2175	2175	2175	2175
4.03	Free lifting height	h <sub>2</sub>	mm	90	90	90	90
4.04	Lifting height (standard)	h <sub>3</sub>	mm	3300	3300	3300	3300
4.05	Max. height,extended	h <sub>4</sub>	mm	4039	4039	4039	4039
4.06	Height of overhead guard	h <sub>6</sub>	mm	2040	2040	2040	2040
4.07	Height of seat	h <sub>7</sub>	mm	1047	1047	1064	1064
4.08	Towing coupling height	h <sub>10</sub>	mm	375	375	375	375
4.09	Overall length (with fork)	l <sub>1</sub>	mm	2850	2850	2970	2970
4.10	Overall length (without fork)	l <sub>2</sub>	mm	1930	1930	2055	2055
4.11	Overall width	b <sub>1</sub>	mm	1060/1076	1060/1076	1060/1120	1060/1120
4.12	Fork carriage,DIN standard			2A	2A	2A	2A
4.13	Fork size:thickness x width x length	s/e/l	mm	35/100/920	35/100/920	35/100/920	40/122/920
4.14	Distance between fork-arms, Max./Min.	b <sub>5</sub>	mm	960/200	960/200	960/200	960/200
4.15	Ground clearance (laden,between mast)	m <sub>1</sub>	mm	90	90	90	90
4.16	Ground clearance (center of wheelbase)	m <sub>2</sub>	mm	100	100	100	100
4.17	Right angle stacker aisle width for pallet 1000x1200mm crossways	A <sub>st</sub>	mm	3120	3120	3245	3250
4.18	Right angle stacker aisle width for pallet 800x1200mm lengthways	A <sub>st</sub>	mm	3320	3320	3445	3450
4.19	Min. outside turning radius	W <sub>a</sub>	mm	1545	1545	1675	1675
<b>Performance Data</b>							
5.01	Travel speed (laden/unladen)		km/h	16/17	16/17	16/16	16/16
5.02	Lift speed (laden/unladen)		m/s	0.45/0.65	0.45/0.65	0.41/0.6	0.4/0.6
5.03	Lowering speed (laden/unladen)		m/s	0.58/0.5	0.58/0.5	0.58/0.5	0.58/0.5
5.04	Max.drawbar pull (laden/unladen)		N	12000/8750	12000/8750	14200/11000	14200/11000
5.05	Max.gradeability (laden/unladen)		%	22/30	22/30	22/30	22/30
5.06	Acceleration time(10 m)(laden/unladen)		s	5.4/5	5.4/5	5.4/5	5.4/5
<b>Battery</b>							
6.01	Battery voltage/Capacity		V/Ah	80/202	80/202	80/202	80/202
6.02	Battery weight (Min./Max.)		kg	260/320	260/320	260/320	260/320
<b>Motor and controller</b>							
7.01	Driving motor powering (S2-60min)		kW	5.5x2	5.5x2	5.5x2	5.5x2
7.02	Lifting motor powering (S3-15%)		kW	14	14	14	14
7.03	Driving motor controlling mode			MOSFET/AC			
7.04	Lifting motor controlling mode			MOSFET/AC			
<b>Addition data</b>							
8.01	Service brake/Parking brake			Hydraulic/Hydraulic(automatic parking)			
8.02	Operating pressure for attachments		Mpa	17.5	17.5	17.5	17.5

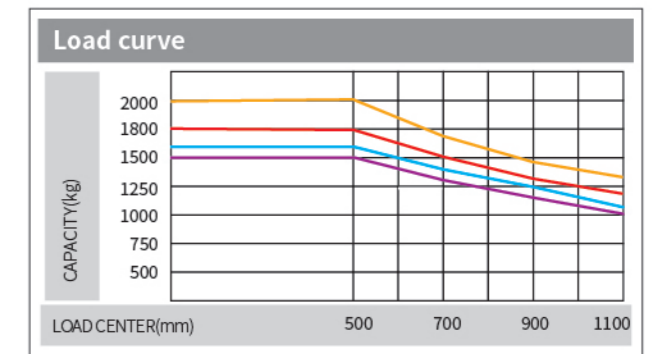
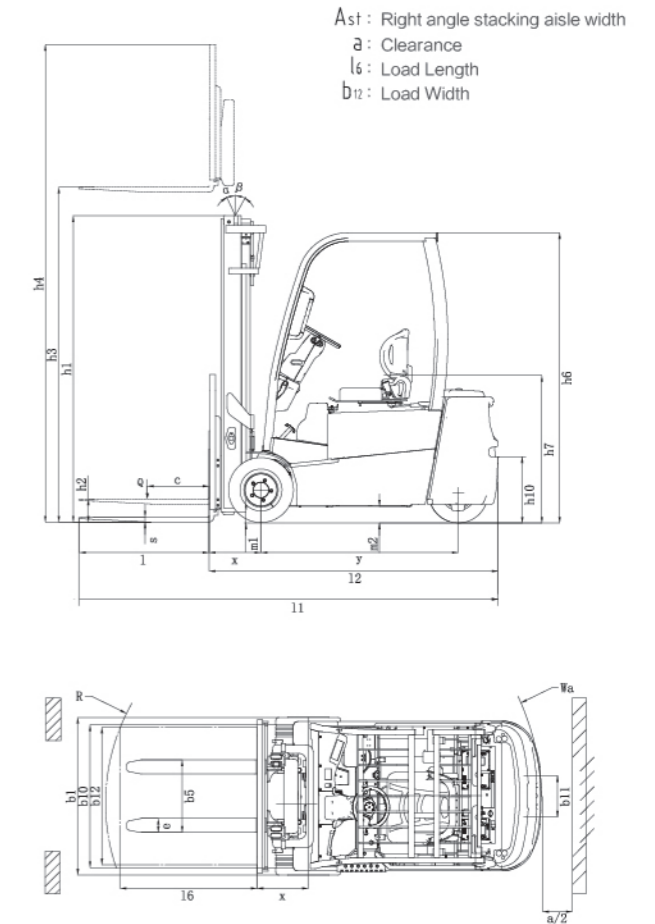

CPD15SQ CPD16SQ CPD18SQ CPD20SQ

**Note:**The vertical axis stands for load capacity and the horizontal axis stands for load center which is calculated from the front surface of the forks to the gravity of the standard load. The standard load means a cubic with 1000mm edge length. When mast is tilted forward, using non-standard forks or loading large goods, the load capacity will be reduced. The load capacity of standard mast at different load center can be known from this load chart.

Note:For configuration number, 1 : CURTIS Controller;2:ZAPI Controller;6 : HELI TECHNOLOGY Controller.



WIDE VIEW MAST											
Mast model	Max lifting height mm	Load capacity (load center 500mm)				Mast overall height (fork to the ground)	Service weight				Mast tilting angle (°) α/β
		1.5t	1.6t	1.8t	2.0t		1.5-2t	1.5t	1.6t	1.8t	
M200	2000	1500	1600	1800	2000	1525	2828	2863	3144	3249	5/7
M250	2500	1500	1600	1800	2000	1775	2855	2890	3181	3286	5/7
M300	3000	1500	1600	1800	2000	2025	2884	2909	3209	3314	5/7
M330	3300	1500	1600	1800	2000	2175	2900	2935	3225	3330	5/7
M350	3500	1500	1600	1750	2000	2275	2911	2936	3236	3341	5/7
M370	3700	1500	1600	1750	2000	2375	2922	2947	3247	3352	5/7
M400	4000	1500	1600	1750	1950	2575	2965	2990	3290	3395	3/5
M425	4250	1500	1600	1750	1900	2700	3007	3033	3333	3438	3/5
M450	4500	1400	1500	1700	1850	2825	3023	3048	3348	3453	3/5
M500	5000	1300	1400	1600	1700	3075	3054	3079	3379	3484	3/5

WIDE VIEW FULL FREE 2-STAGE MAST												
Mast model	Max lifting height mm	Load capacity (load center 500mm)				Mast overall height (fork to the ground)	Free lifting height (with backrest)	Service weight				Mast tilting angle (°) α/β
		1.5t	1.6t	1.8t	2.0t			1.5t	1.6t	1.8t	2.0t	
ZM200	2000	1500	1600	1800	2000	1525	510	2855	2890	3182	3235	5/7
ZM250	2500	1500	1600	1800	2000	1775	760	2884	2919	3209	3264	5/7
ZM300	3000	1500	1600	1800	2000	2025	1010	2912	2937	3237	3292	5/7
ZM330	3300	1500	1600	1800	2000	2175	1160	2930	2965	3255	3300	5/7
ZM350	3500	1500	1600	1750	2000	2275	1260	2941	2966	3266	3321	5/7
ZM370	3700	1500	1600	1750	2000	2375	1360	2955	2980	3280	3355	5/7
ZM400	4000	1500	1600	1750	1950	2575	1560	3000	3025	3325	3380	3/5

WIDE VIEW FULL FREE 3-STAGE MAST												
Mast model	Max lifting height mm	Load capacity (load center 500mm)				Mast overall height (fork to the ground)	Free lifting height (with backrest)	Service weight				Mast tilting angle (°) α/β
		1.5t	1.6t	1.8t	2.0t			1.5t	1.6t	1.8t	2.0t	
ZSM360	3600	1500	1600	1750	2000	1790	781	3044	3079	3369	3524	3/5
ZSM400	4000	1500	1600	1750	2000	1925	916	3069	3104	3394	3549	3/5
ZSM435	4350	1400	1500	1700	1900	2040	1031	3097	3132	3422	3577	3/5
ZSM450	4500	1400	1500	1700	1850	2090	1081	3108	3143	3433	3588	3/5
ZSM470	4700	1350	1450	1650	1750	2160	1151	3124	3159	3446	3601	3/5
ZSM480	4800	1350	1450	1650	1750	2190	1181	3129	3164	3451	3606	3/5
ZSM500	5000	1200	1300	1600	1700	2290	1281	3151	3186	3473	3628	3/5
ZSM540	5400	1050	1150	1250	1400	2425	1416	3207	3242	3529	3684	3/3
ZSM600	6000	800	900	1000	1100	2640	1631	3247	3282	3569	3724	3/3
ZSM650	6500	700	800	900	1000	2830	1821	3289	3324	3611	3766	3/3

LITHIUM BATTERY CHARGER					
Lithium battery brand	HELI		CATL		EIKTO
Voltage/Capacity	80V/202	80V/271	80V/202	80V/271	80V/271
CPD15/16/18/20SQ	●	○	○	○	○
Low temperature heating of lithium battery	●				
Charger	D80V200ALi-123 D80V200ALi-423				
Note: ● standard ○ optional — non-configurable					

Optional			
Security class	Steering automatic deceleration	●	
	Reversing handle with horn button	●	
	OPS system(Excluding descent)	●	
	Complete OPS system	○	
	Seat belt switch	●	
	Multi way valve overload	●	
	Fire extinguisher	○	
	Backward buzzer	●	
	Reversing Chinese language horn	○	
	Electronic upper buffer	●	
	Rearview mirror with angle in the middle	●	
	Left and right rear mirror	○	
	Tilt speed limit	●	
	Active stabilization (Standard configuration for full free 3-stage mast above 4m)	●	
Comfort class	Standard seat	●	
	Fully suspended seat	○	
	USB power	●	
	Mechanical valve	●	
	Solenoid valve (proportional valve + thumb switch)	○	
	Fan	○	
	Color screen instrument	●	
	Heater	○	
	Performance mode control	●	
	Steering wheel with operation ball	●	
	Steering wheel without operation ball	○	
	Non standard overhead guard	The height of overhead guard is increased by 50mm	○
		Overhead guard with protective net	○
	Cab/windshield glass	Cab	○
Fit the front windshield		○	
Equipped with rear windshield		○	
Light class	Equipped with top rain glass	○	
	No rear work lights or rear blue lights	●	
	LED rear work light	○	
	LED rear blue light (without switch control)	○	
	led rear work light and led rear blue light (without switch control)	○	
	LED flickering warning light	●	
	LED rotary warning light	○	
	Led rotary buzzer warning light	○	
	HEDING lithium battery	●	
	ENEROC lithium battery	○	
	EIKTO lithium battery	○	
	Solid tire	●	
	Traceless tyre	○	
	Other	Single tire (front wheel)	●
Double tire (front wheel)		-	
Metric thread		●	
American thread		○	
Sleeve for Tilting cylinder		○	
Tilting cylinder,sleeve for steering cylinder		○	
HELI package		●	
Neutral package		○	
Chinese sticker		●	
English sticker		○	
Custom-made sticker		○	
HELI smart fleet management system(standard version)		○	

Note: ● standard ○ optional — non-configurable